

Dimensioning Hole Features

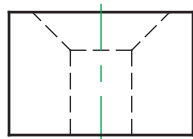

Countersink

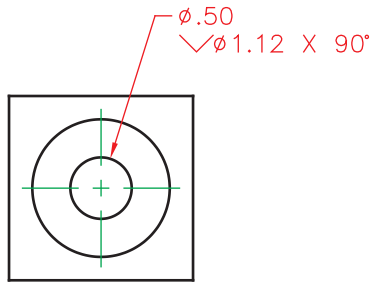
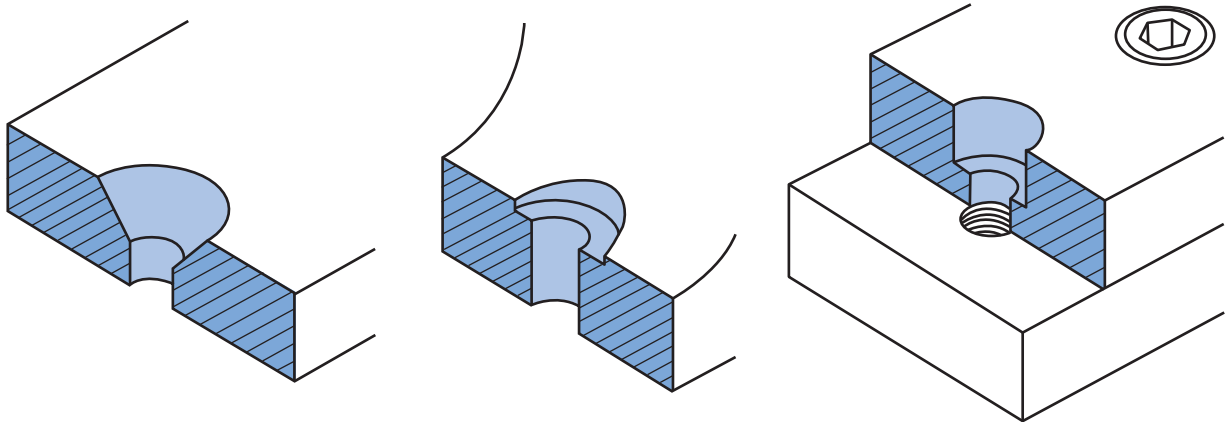
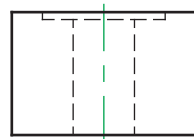
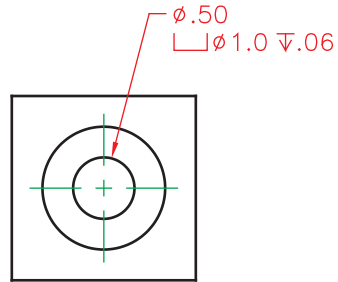

Spotface

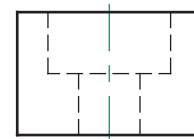
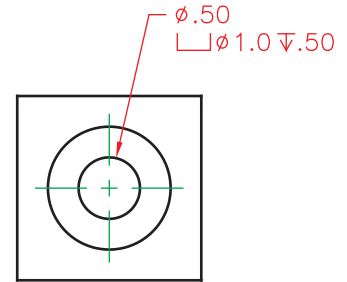

Counterbore